



MORA ONE bath mixer

Mora One is an elegant and strict series of mixers expressing usability, beauty and durability. Mora One is inspired by the 90-year old history of Mora Armatur, but is designed for a modern home. An inspiration to Thomas Sandell, architect and designer, when developing the Mora One was the classical outdoor water pump. Mora One has the same conical body and sharp transitions to the flat surfaces as an old water pump. Mora One has an advanced and reliable technique. The mixers are contributing to a more sustainable environment by saving as much water and energy as possible without compromising on comfort.

Article number: 260000

Description: Chrome, 160 c/c

Uniqe characteristics

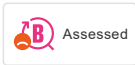

Backflow protection unit type 

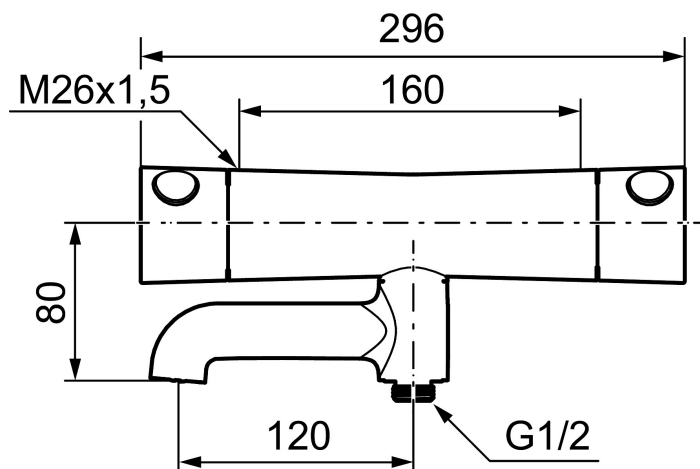

- Swivel spout with built-in diverter
- Pressure balanced thermostatic mixer
- Temperature handle with safety stop at 38°C
- With Eco-function
- Approved non-return valves, EN-Standard EN1717

PRODUCT DESCRIPTION

MORA ONE bath mixer

Mora One is an elegant and strict series of mixers expressing usability, beauty and durability. Mora One is inspired by the 90-year old history of Mora Armatur, but is designed for a modern home. An inspiration to Thomas Sandell, architect and designer, when developing the Mora One was the classical outdoor water pump. Mora One has the same conical body and sharp transitions to the flat surfaces as an old water pump. Mora One has an advanced and reliable technique. The mixers are contributing to a more sustainable environment by saving as much water and energy as possible without compromising on comfort.

Article number: 260000

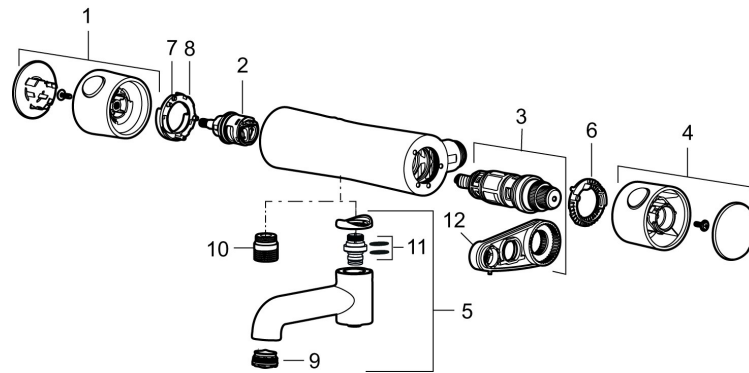

Sparepartlist

NO.	ART NO.	RSK	DESCRIPTION
1	409553.AE	8218895	On/off handle, complete, chrome
2	707977.AE		Ceramic headwork, reversible
3	409355.AE	8345136	Thermostatic cartridge, complete, with service tool
4	409554.AE	8218896	Temperature handle, complete, chrome
5	409556	8314145	Swivel spout, for conversion of shower mixer to bath/shower mixer, chrome
6	209559.AE		Scalding protection ring
7	707900.AE		Stop ring, standard
8	707901.AE		Stop ring, reversible
9	409566.AE	8281450	Aerator
10	409659.AE	8187025	Shower connector M18x1xG1/2
11	209519.AE	8938340	O-ring, for swivel spout
12	891096.AE	8345921	Service tool