



MORA MMIX K7 kitchen mixer

Mora MMIX combines elegance and ergonomic design with energy-efficiency. Soft geometric curves and a timeless style characterise the entire Mora MMIX range. The mixers were developed according to our unique EcoSafe™ concept focusing on low energy consumption and long-term environmental care.

Article number: 732071 Flow 3 bar: 7.5 l/m

Description: Chrome

Unique characteristics



Backflow protection unit type 

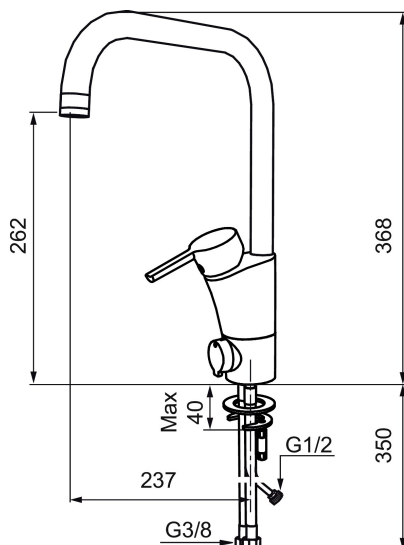

- ESS (energy saving system)
- Ceramic cartridge with soft closing function
- Adjustable flow control and temperature limiter
- Eco (energy and water saving aerator)
- Soft PEX® hoses with 3/8" connecting nut (stainless steel braided)
- Swivel spout, limitation part for 60°, 85°, 110° or 360° included
- With dishwasher valve, switchable between cold and hot water. Pre-set on cold water
- Lead Free material
- Hole diameter Ø32-37 mm