



MORA REXX K5 kitchen mixer

With their simple, minimalist design, Mora REXX mixers are the essence of Scandinavian design and functionality. Their innovation lies in their precision. When tradition and craftsmanship meet state-of-the-art manufacturing methods and inspiring design, the result is Mora REXX. The version shown here is a beautiful kitchen mixer with built-in intelligent function.

Article number: 707105 Flow 3 bar: 7.7 l/m

Description: Chrome

Unique characteristics

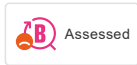

Backflow protection unit type

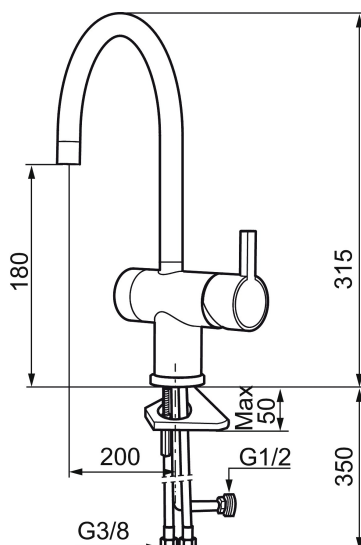

- ESS (energy saving system)
- Ceramic cartridge
- Adjustable flow control and temperature limiter
- Eco (energy and water saving constant flow aerator, 7,6 l/min at 200–600 kPa)
- Soft PEX[®] hoses with 3/8" connecting nut (stainless steel braided)
- Swivel spout, limitation part for 60°, 120° or 360° included
- With dishwasher valve, switchable between cold and hot water. Pre-set on cold water
- Hole diameter Ø32-35 mm

PRODUCT DESCRIPTION

MORA REXX K5 kitchen mixer

With their simple, minimalist design, Mora REXX mixers are the essence of Scandinavian design and functionality. Their innovation lies in their precision. When tradition and craftsmanship meet state-of-the-art manufacturing methods and inspiring design, the result is Mora REXX. The version shown here is a beautiful kitchen mixer with built-in intelligent function.

Article number: 707105

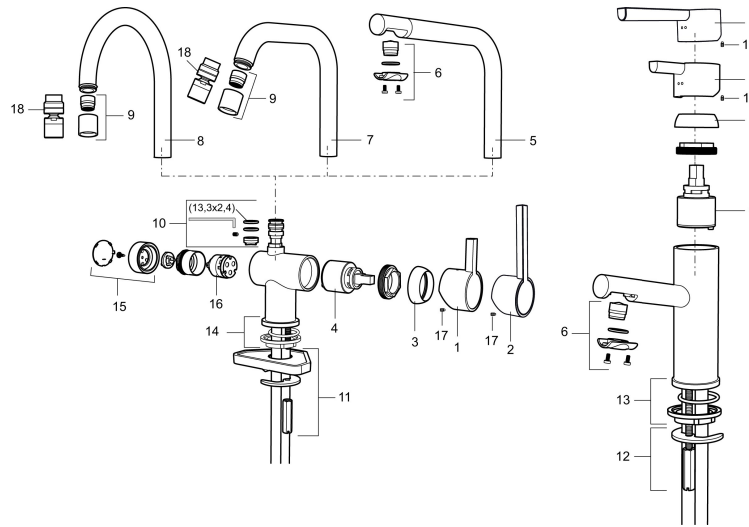

Sparepartlist

NO.	ART NO.	RSK	DESCRIPTION
	209560.AC	8345784	Rubber gasket for Soft-PEX® pipe 3/8, 10-pcs
1	209500.AE	8346901	Handle, chrome
1	209500.0011AE	8346917	Handle, chrome/black
2	409337	8346503	Care-handle, chrome
3	209501.AE	8346902	Cover nut, chrome
4	209493.AE	8345204	Ceramic cartridge, ESS
4	708301.AE	8345093	Ceramic cartridge
5	209506.AE	8346907	L-spout, complete, chrome
5	209506.0011AE	8326728	L-spout, complete, chrome/black
6	209502.AE	8346903	Aerator kit, L-spout, 7,6 l/min at 200–600 kPa, chrome
6	209502.0011AE	8346921	Aerator kit, L-spout, 7,6 l/min at 200–600 kPa, chrome/black
7	209508.AE	8346909	J-spout, complete, chrome
8	209507.AE	8346908	C-spout, complete, chrome
9	209503.AE	8346904	Aerator M18 int., 7,6 l/min at 200–600 kPa, chrome
10	209520.AE	8346910	Gasket kit, incl. o-rings, limitation part, screw and wrench

NO.	ART NO.	RSK	DESCRIPTION
11	708779.AE		Fastening details, kitchen
12	209518.AE	8346911	Fastening details
13	209562.AE		Locating ring, basin
14	209563.AE	8295335	Locating ring, kitchen
15	209505.AE	8346906	Handle for dishwasher connection, chrome
16	209504.AE	8346905	Ceramic cartridge for dish washer connection CW/HW, incl. service tool
17	459013		Locking screw
18	409480.AE	8393983	Aerator M18 int., ball joint, 7–9 l/min at 300 kPa