



MORA INXX II bath mixer

With its durable matt black finish and hand shower with a large, round nozzle, makes this mixer looks great and gives a truly relaxing baths. The INXX II collection offers a world-class water experience with constant temperature, high comfort and effective scald protection. The mixer has been tested and approved according to current building regulations and is energy-efficient, which means it reduces water and energy use without compromising on comfort.

About the collection

INXX II is an elegant, timeless collection in a palette of carefully selected colours. Offering a combination of high quality, sober design and outstanding comfort, this is the ultimate collection.

Article number: 270100.12 **Flow 3 bar:** 20.0 l/m

Description: Matte black, 150 c/c

Unique characteristics

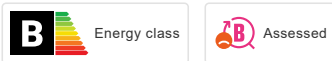

Backflow protection unit type **EB**

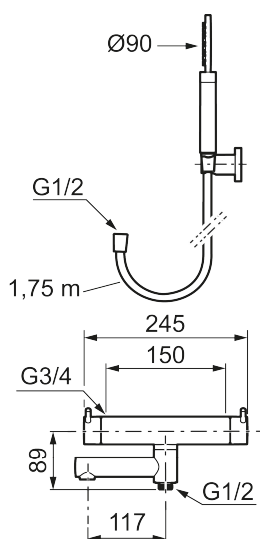

- With hand shower, holder and hose in metal, PVC- and BPA-free
- Swivel spout with built-in diverter
- Pressure balanced thermostatic mixer
- Temperature handle with safety stop at 38°C
- With Eco-function
- Approved non-return valves, EN-Standard EN1717

PRODUCT DESCRIPTION

MORA INXX II bath mixer

With its durable matt black finish and hand shower with a large, round nozzle, makes this mixer looks great and gives a truly relaxing baths. The INXX II collection offers a world-class water experience with constant temperature, high comfort and effective scald protection. The mixer has been tested and approved according to current building regulations and is energy-efficient, which means it reduces water and energy use without compromising on comfort.

About the collection

INXX II is an elegant, timeless collection in a palette of carefully selected colours. Offering a combination of high quality, sober design and outstanding comfort, this is the ultimate collection.

Article number: 270100.12

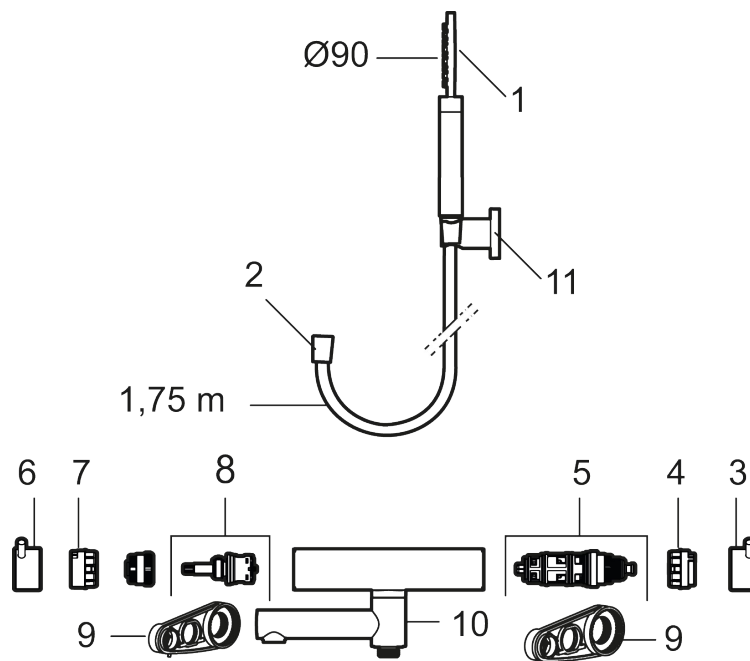

Sparepartlist

NO.	ART NO.	RSK	DESCRIPTION
1	209575	8275496	Hand shower, chrome
1	209575.12	8275497	Hand shower, matte black
1	209575.22	8275498	Hand shower, matte white
1	209575.44	8275499	Hand shower, matte grey
1	209575.60	8275500	Hand shower, polished brass PVD
1	209575.62	8275501	Hand shower, brused brass PVD
2	131170.AE	8251927	Shower hose in metal, 1750 mm, chrome

NO.	ART NO.	RSK	DESCRIPTION
2	131170.12AE	8251999	Shower hose in metal, 1750 mm, matte black
2	131170.22AE	8252000	Shower hose in metal, 1750 mm, matte white
2	131170.44AE	8252001	Shower hose in metal, 1750 mm, matte grey
2	131170.60AE	8252002	Shower hose in metal, 1750 mm, polished brass PVD
2	131170.62AE	8252003	Shower hose in metal, 1750 mm, brused brass PVD
3	409710.AE	8218902	Temperature handle, chrome
3	409710.12AE	8218903	Temperature handle, matte black
3	409710.22AE	8218904	Temperature handle, matte white
3	409710.44AE	8218905	Temperature handle, matte grey
3	409710.60AE	8218906	Temperature handle, polished brass PVD
3	409710.62AE	8218907	Temperature handle, brused brass PVD
4	S600023	8439703	Stop ring
5	S600019	8439702	Thermostatic cartridge, complete, with service tool
6	409711.AE	8218901	Temperature handle, chrome
6	409711.12AE	8218908	Temperature handle, matte black
6	409711.22AE	8218909	Temperature handle, matte white
6	409711.44AE	8218910	Temperature handle, matte grey
6	409711.60AE	8218911	Temperature handle, polished brass PVD
6	409711.62AE	8218912	Temperature handle, brused brass PVD
7	S600024	8439705	Stop ring, reversible
8	S600021	8441463	Ceramic headwork, with service tool (bath mixer)
9	891096.AE	8345921	Service tool
10	S600161	8440630	Swivel spout, for coversion of shower mixer to bath/shower mixer, chrome
10	S600161.12	8440631	Swivel spout, for coversion of shower mixer to bath/shower mixer, matte black
10	S600161.22	8440632	Swivel spout, for coversion of shower mixer to bath/shower mixer, matte white
10	S600161.44	8440633	Swivel spout, for coversion of shower mixer to bath/shower mixer, matte grey
10	S600161.60	8440634	Swivel spout, for coversion of shower mixer to bath/shower mixer, polished brass PVD
10	S600161.62	8440635	Swivel spout, for coversion of shower mixer to bath/shower mixer, brushed brass PVD
11	S600256	8239634	Hand shower holder, chrome
11	S600256.12	8239635	Hand shower holder, matte black
11	S600256.60	8239638	Hand shower holder, polished brass PVD
11	S600256.62	8239639	Hand shower holder, brushed brass PVD