



MORA MMIX K7 kitchen mixer

Mora MMIX combines elegance and ergonomic design with energy-efficiency. Soft geometric curves and a timeless style characterise the entire Mora MMIX range. The mixers were developed according to our unique EcoSafe™ concept focusing on low energy consumption and long-term environmental care.

Article number: 732071 Flow 3 bar: 7.5 l/m

Description: Chrome

Unique characteristics



Backflow protection unit type **AA**

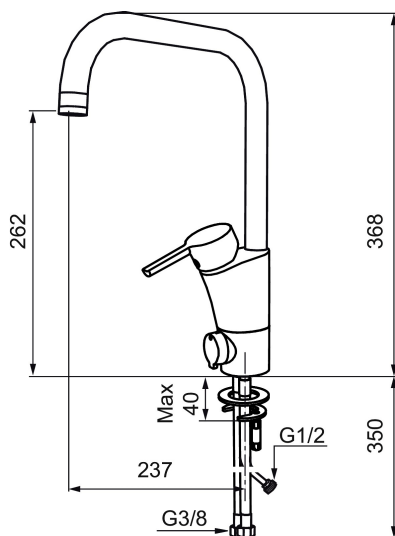

- ESS (energy saving system)
- Ceramic cartridge with soft closing function
- Adjustable flow control and temperature limiter
- Eco (energy and water saving aerator)
- Soft PEX® hoses with 3/8" connecting nut (stainless steel braided)
- Swivel spout, limitation part for 60°, 85°, 110° or 360° included
- With dishwasher valve, switchable between cold and hot water. Pre-set on cold water
- Lead Free material
- Hole diameter Ø32-37 mm

PRODUCT DESCRIPTION

MORA MMIX K7 kitchen mixer

Mora MMIX combines elegance and ergonomic design with energy-efficiency. Soft geometric curves and a timeless style characterise the entire Mora MMIX range. The mixers were developed according to our unique EcoSafe™ concept focusing on low energy consumption and long-term environmental care.

Article number: 732071

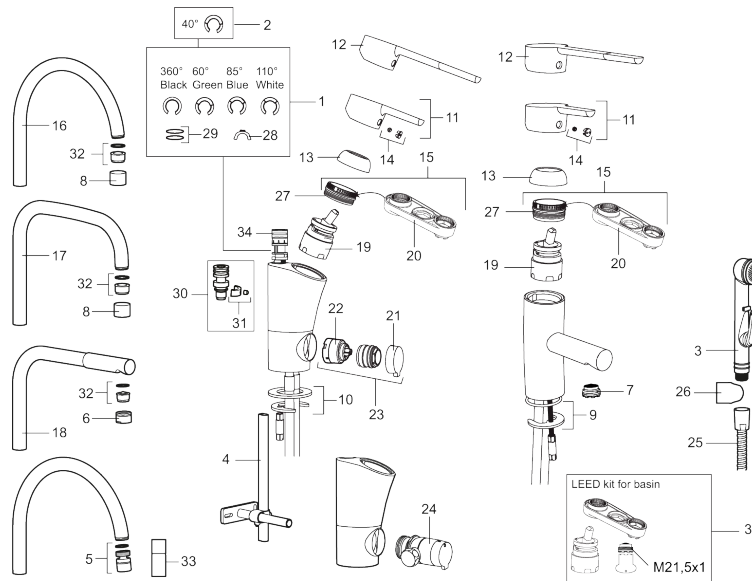

Sparepartlist

NO.	ART NO.	RSK	DESCRIPTION
1	S600299	8387254	Limitation segment
2	209543.AE	8346916	Limitation segment 40°
3	S600206	8233049	Self-closing hand shower, chrome
4	S600308	8387263	Stabilizer kit
5	S600314	8280068	Aerator M22 int., ball joint, 7–9 l/min at 300 kPa
6	131415.AE	8281512	Housing M24 utv., 15 mm, chrome
7	S600312	8280067	Aerator M21,5 ext., 7–9 l/min at 300 kPa
7	409385.AE	8242292	Aerator M21,5 ext., 5 l/min at 200–600 kPa
7	S600228		Aerator M21,5 ext., 3 l/min at 200–600 kPa
8	131410.AE	8281509	Housing M22 int.
9	S600160	8387096	Fastening kit, for basin mixer
10	S600159	8387097	Fastening kit, for kitchen mixer
11	409389.AE	8344867	Lever, complete
12	409390.AE	8344874	Care lever, complete, chrome
13	409391.AE	8344865	Cover nut

NO.	ART NO.	RSK	DESCRIPTION
14	409392.AE	8344866	Colour marking and mounting screw for lever
15	409393.AE	8345179	Lock nut for cartridge, incl service tool
16	409395.AE	8326732	Spout K5, complete
17	409396.AE	8326733	Spout K7, complete
18	409397.AE	8326734	Spout K6, complete
19	S600273	8387230	Ceramic cartridge with service tool, cold start (green ring)
19	409405.AE	8345205	Ceramic cartridge, Turbo, incl service tool
19	S600232		Cartridge, Low flow, for LEED mixers
20	S600298	3870203	Service tool
21	409400.AE	8345180	Handle for dish washer connection
22	S600337	8346905	Ceramic cartridge for dishwasher, with service tool
22	S600316	8387265	Ceramic cartridge for dishwasher, without service tool
23	409104.AE	8322314	Dishwasher isolator cartridge, incl. service tool
24	409399.AE	8347223	Rebuild.kit for dish washer
25	S600207	8236647	Shower hose, L=1,5 m, chrome
26	130732.AE	8184186	Wall bracket
27	439060.AE	8295361	Lock nut
28	309519.AE	8295318	Fixed plug, 2 pcs (black/grey)
29	708843.AE	8295357	O-ring (15,54 x 2,62), 2 pcs
30	109016.AE	8295331	Spout nipple, complete, for fixed spout
31	139595.AE	8295313	Stop screw with limitation segment
32	S600319	8280069	Aerator insert, 7–9 l/min at 300 kPa
32	131400.AE	8281495	Aerator insert, 11–15 l/min at 300 kPa
32	132408.AE	8281439	Aerator insert, 8 l/min at 200–600 kPa
33	409343.AE	8281537	Aerator M22 int., ball joint, 7–9 l/min at 300 kPa
34	S600018	8394128	Spout nipple, complete
35	131407.AE	8281482	LEED kit for basin mixer, 3 l/min at 200-600 kPa