



## MORA GARDEN II

Article number: 700979

Description: Chrome, L=150 mm

- With frost-proof positioned backflow prevention device, incl. non-return valve
- Key and metal handle included
- Sliding wall plate for adjustment to wall thickness, or projection
- Solder- and thread connection
- Hose connection 3/4 thread
- Approved backflow prevention device, EN-Standard EN 1717

Unique characteristics

Backflow protection unit type  HD

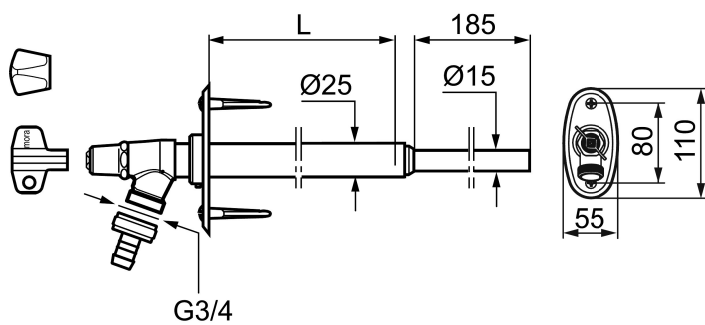

PRODUCT DESCRIPTION

MORA GARDEN II

Article number: 700979

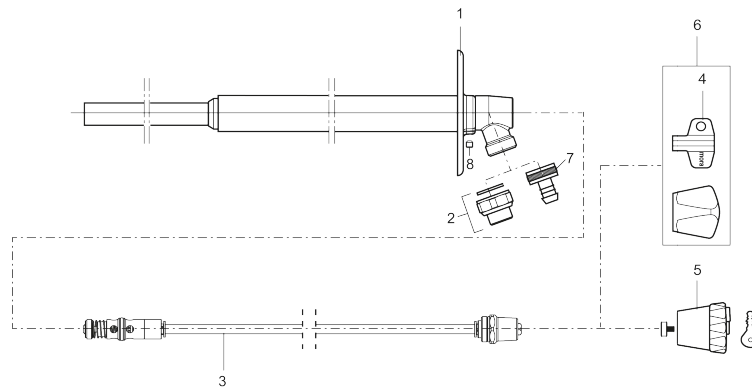

Sparepartlist

NO.	ART NO.	RSK	DESCRIPTION
1	409292.AE	5438343	Wall plate
2	640000.AE	8187010	Transition nipple 1/2" ext - 3/4" int, with gasket
3	409267.AE		Spindle complete with silicon hose 150 mm
3	409318.AE		Spindle complete with silicon hose 200 mm
3	409268.AE	8938269	Spindle complete with silicon hose 300 mm
3	409269.AE	8588934	Spindle complete with silicon hose 400 mm
3	409270.AE		Spindle complete with silicon hose 500 mm
4	630520.AE	8938265	Key, 1 pcs
4	630520.AC	8938266	Key, 10 pcs
5	409213.AE	8938275	Lockable handle
6	409304.AE		Metallic handle and key
7	709563.AE		Hose connection G3/4
8	409176.AE		Screw M6x6