



## Wall Plate for PE-X-, PE-RT-, PB- and multilayer-pipes, 160 c/c

We have a wide selection of wall plate in a choice of six colours, with screws that match the colour of the plate. Brackets are available for the models P-EX 15 and P-EX 16 and in 150 and 160 c/c.

Article number: 650281.60

Description: Polished brass PVD, D: Ø16

Unique characteristics

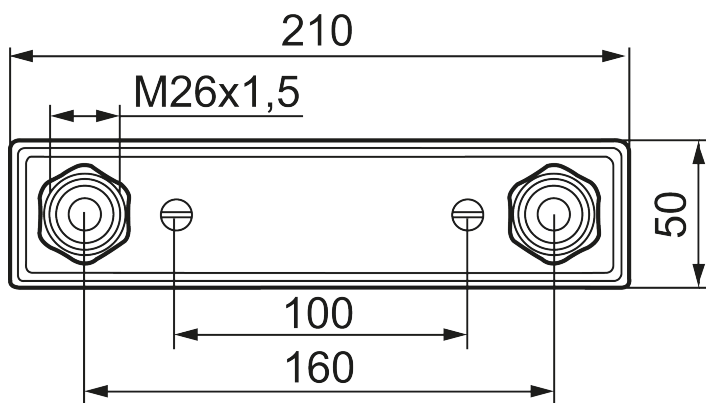

- For concealed fitting
- With screws and wall seal
- Connection remains on the surface of the wall

**Connections has product certification issued by a product certification body in Sweden, RISE Certification, for:**

- PE-X enligt EN ISO 15875: 15x2.5, 16x2.0 & 16x2.2
- PE-RT enligt EN ISO 22391: 15x2.5 & 16x2.2
- PB enligt EN ISO 15876: 16x2.0

**Multilayer pipe by manufacture:**

- Uponor UNI PIPE PE-RT/AL/PE-RT 16\*2
- Thermotech MultiSystem AluComposite PE-RT Type2/AL/PE-RT Typ2 16\*2
- Roth Systemrohr Alu-Laserplus 16\*2 mm PE-RT TypII/Al/PE-RT TypII
- LK PAL Universal Pipe A16 16\*2,0
- TECElogo dimension 16 – multilayer pipe – PE-RT/Al/PE-RT 16\*2,0 mm
- TECElogo dimension 16 – multilayer pipe – PE-Xc/Al/PE-RT 16\*2,0 mm
- FRÄNKISCHE turatec multi 16\*2 PE-RT III/Al/PE-RT II
- HENCO RIXc PE-Xc/Al/PE-Xc 16\*2