



MMIX II bath mixer

We have updated our classic MMIX chrome bathtub mixer – now featuring refined, straighter lines and a bolder expression, highlighting its exceptional function and elegance. Its interior has also been upgraded with an improved thermostat for optimal energy efficiency.

Article number: 330000 Flow 3 bar: 22.9 l/m

Description: Chrome, 160 c/c

- Swivel spout with built-in diverter
- Pressure balanced thermostatic mixer
- Temperature handle with safety stop at 38°C
- With Eco-function
- Lead Free material
- Approved non-return valves, EN-Standard EN1717

Unique characteristics

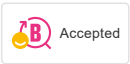

Backflow protection unit type **EB**

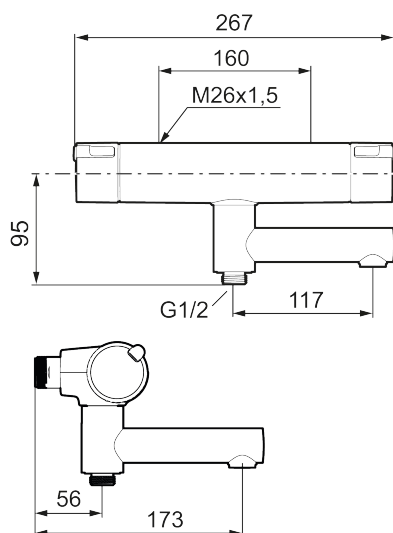

PRODUCT DESCRIPTION

MMIX II bath mixer

We have updated our classic MMIX chrome bathtub mixer – now featuring refined, straighter lines and a bolder expression, highlighting its exceptional function and elegance.

Its interior has also been upgraded with an improved thermostat for optimal energy efficiency.

Article number: 330000

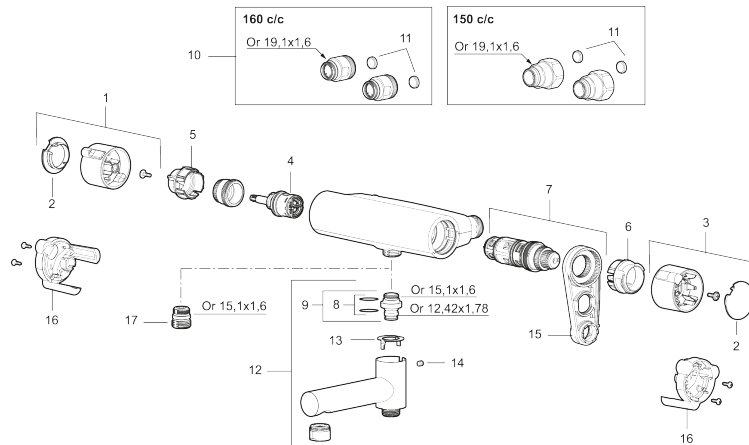

Sparepartlist

NO.	ART NO.	RSK	DESCRIPTION
1	S600191	8397017	On/off handle, complete, chrome
2	S600192	8397019	End cover, chrome, 2 pcs
3	S600190	8397018	Temperature handle, complete, chrome
4	S600020	8441462	Ceramic headwork, with service tool (shower mixer)
4	S600021	8441463	Ceramic headwork, with service tool (bath mixer)
5	S600086	8439710	Stop ring, standard
6	S600087	8439711	Scalding protection ring
6	S600026	8439708	Scalding protection ring, max 42 °C
7	S600084	8439709	Thermostatic cartridge, complete, incl. service tool
8	209519.AE	8938340	O-ring, for swivel spout
9	409366.AE		Nipple M18x1 with o-ring for bath mixer
10	409361.AE	8228492	Inlet connector 160 c/c
11	409359.AA	8345172	Filter kit for connecting links, retail packed
12	409356	8344853	Swivel spout, for conversion of shower mixer to bath/shower mixer, chrome
13	129154.AE	8295332	Stop ring
14	708655.AE	8295447	Locking screw
15	891096.AE	8345921	Service tool

NO.	ART NO.	RSK	DESCRIPTION
16	S600193	8397020	Care-handle, black, 2 pcs
17	S600088	8439712	Nipple M18x1-G1/2 for shower mixer